

**CT4 SERIES RADIAL MULTILAYER (MONO) CERAMIC CAPACITOR**  
**CT42 SERIES AXIAL MULTILAYER (MONO) CERAMIC CAPACITOR**

Features

- Miniature size,wide capacitance  
 Ammo Tape packaging available for auto-placement.
- Coating by epoxy resin,creates the excellent humidity resistance and prevents body from damaging during soldering and washing.
- Industry standard size and vanous load spacing available.

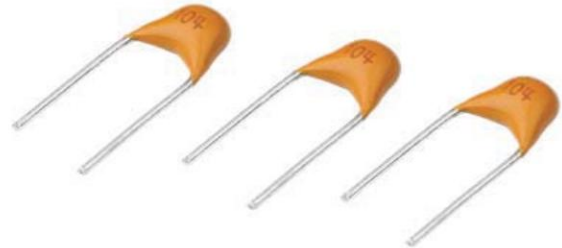

T.C	NPO/COG	X7R(B)	Y5V(Y/F)	Z5U(E)
Dielectric type	Stable Class I Dielectric	Stable ClassII Dielectric		
Electrical properties	With negligible depndence of electrical pro-perties on temperature、 voltage、 frequency and time	With predictable change of properties with temperature、 voltage、 frequency and time,this dielectric is ferroelectric and offers higher capacitance ranges than Class I.	With high twist dielectric constant and greater variation of properties with temperature and test conditions、 very high capacitance per unit volume.	
Application	Use in ciprcuits reoiring stable performance	Use as blocking、 coupling、 By-passing discriminating element.	Suited for By-passing and coupling application such as store power and memory circuit	
Capacitance range	1pF~10nF	100pF~5uF	1nF~14.7uf	
Operating temperature	0±30PPm/c -55°C~+125°C	±15% -55°C~+125°C	+30%~-80% -25°C~+85°C	+22%~-56% -10°C~+85°C



**CT4 SERIES RADIAL MULTILAYER (MONO) CERAMIC CAPACITOR**  
**CT42 SERIES AXIAL MULTILAYER (MONO) CERAMIC CAPACITOR**

**Capacitance Change VS Temperature Characteristic ; Voltage ; Frequency Profiles**

◆ **NPO**

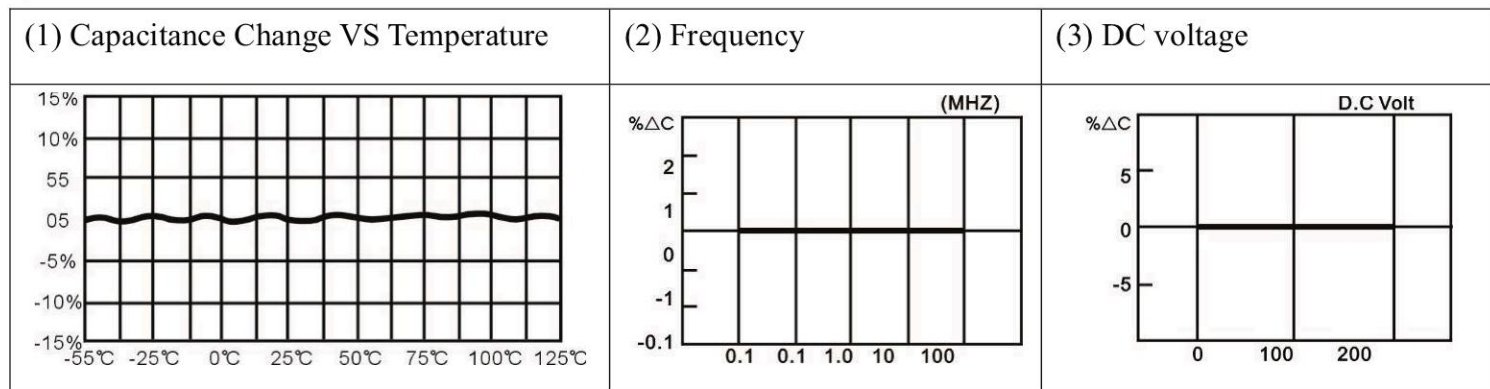

◆ **X7R**

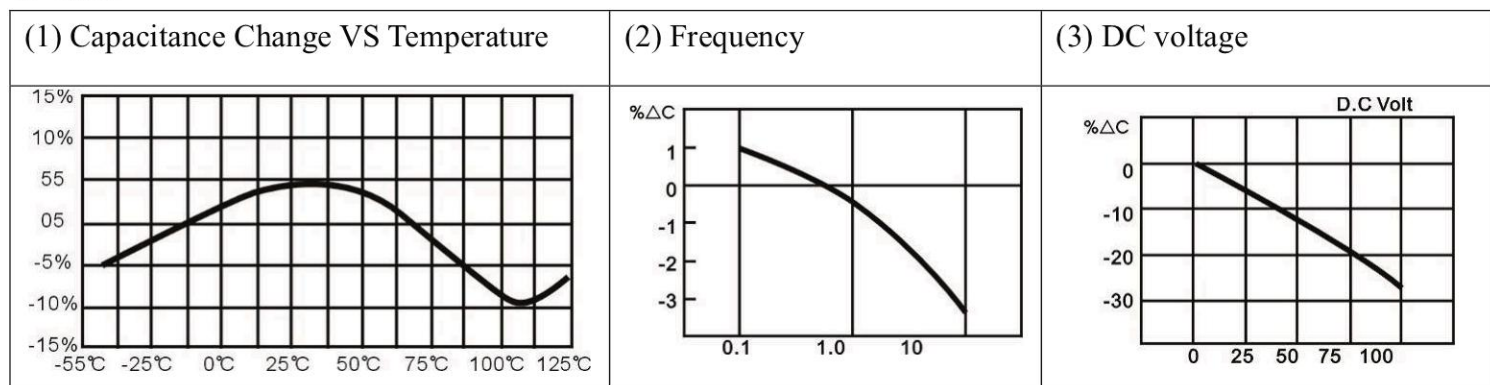

◆ **Z5U**

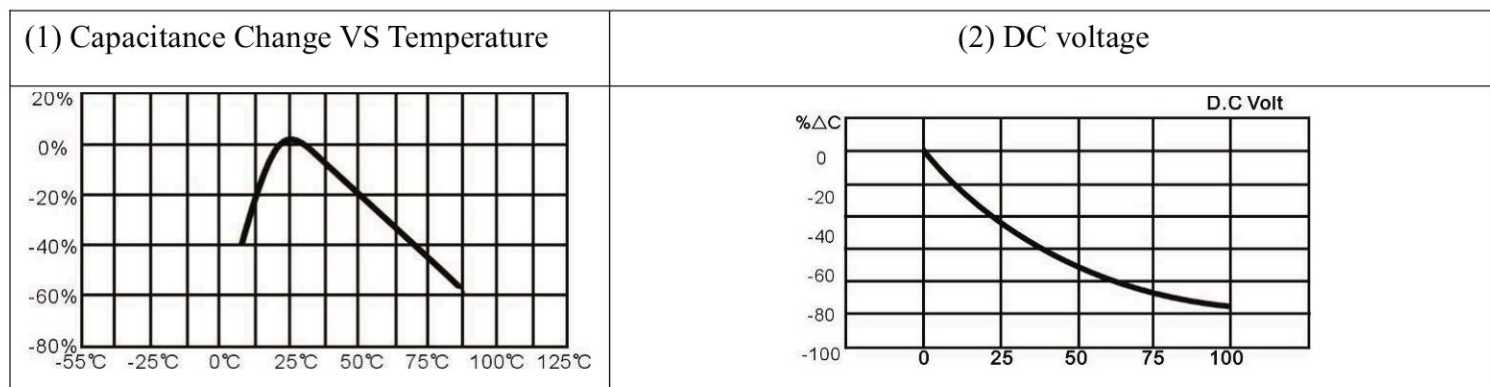

## CT4 SERIES RADIAL MULTILAYER (MONO) CERAMIC CAPACITOR

## CT42 SERIES AXIAL MULTILAYER (MONO) CERAMIC CAPACITOR

### Leaded Multilayer Ceramic Capacitors (Axial Lead, Radial Lead)

#### ◆ Electrical Properties standard

Item	Test standard			
	NPO/CG/GH/RH/UJ/SL	X7R(B)	Z5U(E)	Y5V(Y/F)
Capacitance	±5%	±10%	+80-20%	±20%
Dissipation Factor	<0.15%	<3.5%	<5%	<7.5%(200nF)
				<10% (220~470nF)
				<15%(470~1000nF)
Insulation Resistance	<10nF	<25nF	<25nF	<25nF
	IR<1000C0M Ω	IR>25nF	IR>25nF	IR>25nF
	C>10nF	C>25nF	C>25nF	C>25nF
	R • C>100S	R • C>100S	R • C>100S	R • C>100S
Withstanding Voltage	2.5 rated voltage	2.5 rated voltage	2.5 rated voltage	2.5 rated voltage
Test Condition				
Test Frequency	1 MHZ (C>1000PF 1KHz)	1KHz	1KHz	1KHz
Test Voltage of Cap.&D.F	1 ± 0.2V	1 ± 0.2V	0.3 ± 0.2V	0.3 ± 0.2V
Test Voltage of IR	Rated Voltage	Rated Voltage	Rated Voltage	Rated Voltage
Temperature	10~25°C	10~25°C	10~25°C	10~25°C
Humidity	<75%	<75%	<75%	<75%



**CT4 SERIES RADIAL MULTILAYER (MONO) CERAMIC CAPACITOR**  
**CT42 SERIES AXIAL MULTILAYER (MONO) CERAMIC CAPACITOR**

**Leaded Multilayer Ceramic Capacitors (Axial Lead, Radial Lead)**

◆ **Quality Item & Reliability inspection**





Item	Test Specifications		Test Methods																													
Solderability	Termination area shall be at least 75% covered with a new solder coating.		The lead wire of a capacitor shall be dipped into a 25% methanol solution of rosin and then into molten solder at 235°C for 2 ± 0.5 seconds, in both cases the depth of dipping is up to about 2.5 to 3.0mm from the root of lead.																													
Resistance to soldering heat	There shall be no evidence of damage or flash over during the test and sign in focus.		The lead wire shall be immersed into the melted solder of 260°C ± 5°C up to about 2.5 to 3.0mm from the main body for 5 ± 0.5sec and the specified items shall be measured after leaving for 24 ± 2hours																													
	T.C	$\Delta C/C <$																														
	CG/CH/RH	0.5% or 0.5Pf																														
	UJ/SL	1% or 1pF																														
	B	± 10%																														
	Y(F)/E	± 20%																														
Life test	Appearance	There shall be no evidence of damage or flash over during the test and sign in focus	<table border="1"> <thead> <tr> <th>Condition</th> <th>NPO</th> <th>X7R</th> <th>Y5V</th> <th>Z5U</th> </tr> </thead> <tbody> <tr> <td>Temperature</td> <td colspan="2">+125°C</td> <td colspan="2">+85°C</td> </tr> <tr> <td>Time</td> <td colspan="4">T=1000h</td> </tr> <tr> <td>Voltage</td> <td colspan="4">V=1.5Vr</td> </tr> <tr> <td>Recovery time</td> <td colspan="4">24 ± 1h</td> </tr> </tbody> </table>					Condition	NPO	X7R	Y5V	Z5U	Temperature	+125°C		+85°C		Time	T=1000h				Voltage	V=1.5Vr				Recovery time	24 ± 1h			
	Condition	NPO	X7R	Y5V	Z5U																											
	Temperature	+125°C		+85°C																												
	Time	T=1000h																														
	Voltage	V=1.5Vr																														
Recovery time	24 ± 1h																															
Capacitance change	NPO:<2%;X7R<20%; Y5V:<30%																															
D.F	NPO:<0.3 X7R:<5% Y5V:<7%																															
I.R	R.C<258																															

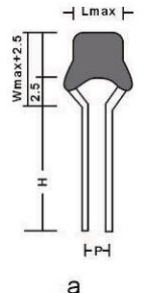
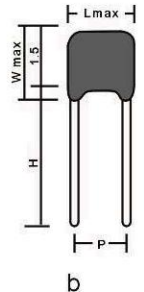
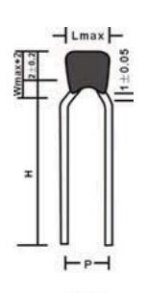

## CT4 SERIES RADIAL MULTILAYER (MONO) CERAMIC CAPACITOR CT42 SERIES AXIAL MULTILAYER (MONO) CERAMIC CAPACITOR

### Leaded Multilayer Ceramic Capacitors (Axial Lead, Radial Lead)

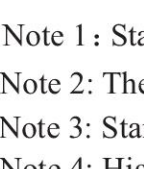
#### ◆ Inside Chip, Shape, Capacitance and Voltage

Inside Chip	Shape	Dimensions(mm)				Voltage	Capacitance(PF)		
		P(±0.5)	Lmax	Wmax	Tmax		NPO	X7R	Y5V(Z5U)
 <p>a</p>	b	2.54	4.2	3.8	3.8	25V	OR5~103	101~105	103~475
	C1	5.08				50V	OR5~103	101~474	103~105
	C3	5.08				100V	OR5~103	101~104	103~104
 <p>b</p>	b	2.54	4.2	3.8	3.8	25V	OR5~103	101~105	103~475
	C1	5.08				50V	OR5~103	101~474	103~105
	C3	5.08				100V	OR5~103	101~104	103~104
 <p>C1</p>	a	2.54	5.5	4.5	3.8	25V	OR5~104	101~225	103~106
	b	2.54				50V	OR5~473	101~225	103~106
	C1	5.08				100V	OR5~473	101~105	103~155
 <p>C3</p>	a	2.54	5.5	5.5	3.8	25V	OR5~104	101~106	103~106
	b	5.08				50V	OR5~473	101~475	103~106
	C1	5.08				100V	OR5~473	101~105	103~155
	b	5.08	8.5	7.0	3.8	25V	OR5~104	101~106	103~106
						50V	OR5~104	101~106	103~106
						100V	OR5~473	101~105	103~155
	b	5.5	10.5	9.5	4.5	25V	OR5~104	101~106	103~106
						50V	OR5~104	101~106	103~106
						100V	OR5~473	101~105	103~155
	b	7.5	12.5	10.5	4.5	25V	OR5~104	101~106	103~106
						50V	OR5~104	101~106	103~106
						100V	OR5~473	101~105	103~155

Note 1: Standard Lead Length 10 +/-1mm& it can be adjusted between 3.0~25mm as per customer requirement

Note 2: The diameter of lead is  $\phi 0.5 \pm 0.05$ mm

Note 3: Standard shape: b, C1, C3; a shape and C2 shape are on request

Note 4: High voltage radial MLCC 200V, 500V, 1000V, 2000V, 3000V .etc are on request.

**CT4 SERIES RADIAL MULTILAYER (MONO) CERAMIC CAPACITOR**  
**CT42 SERIES AXIAL MULTILAYER (MONO) CERAMIC CAPACITOR**

**Radial Lead Multilayer Ceramic Capacitors**

◆ **Package Type: Bulk , Ammo Taped, Tape and Reel**

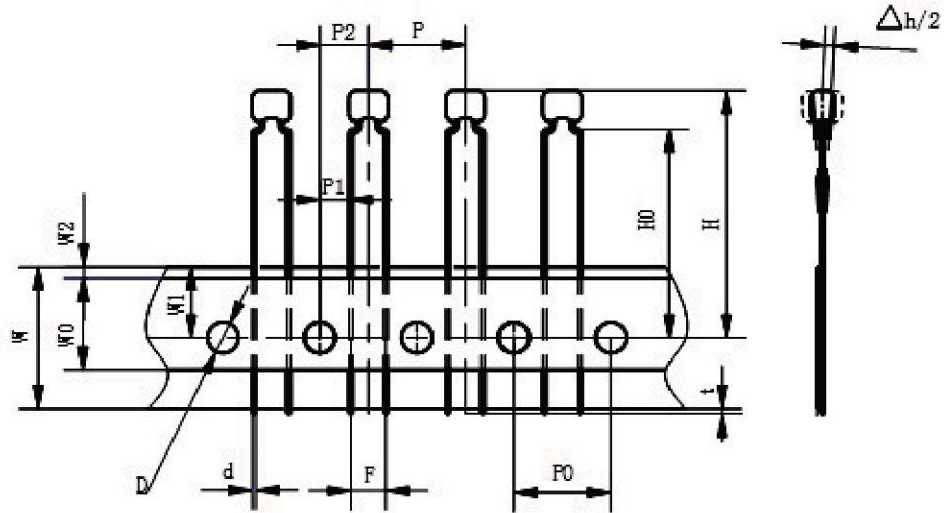

**Note: P1=3.85mm for F=5.08mm P1=5.1mm for F=2.54mm**

Code	P	P0	P1	P2	d	Δh	w	W0	W1	W2	H	H0	D	t
Dim	12.7	12.7	3.85 5.1	6.35	0.5	0	18.5	12	9	1.5	25	15~20	4.0	0.7
Tol	±0.2	±0.2	0.7	±1.3	±0.1	±2	±1	±1	±0.5	±1.5	Max	±0.5	±0.2	Max

**\*Ammo packaging**

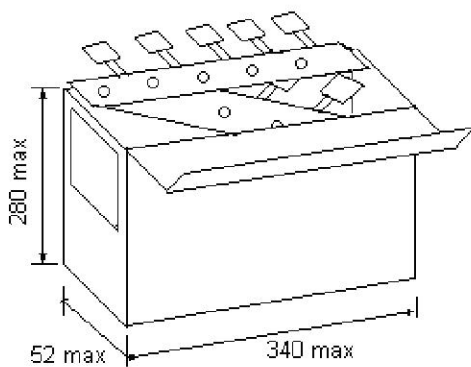

**\*Reel packaging**

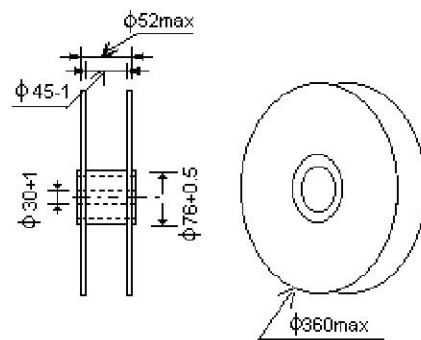

◆ **CT4 Radial MLCC SPQ Info**

Chip Size Code	Bulk	Ammo Taped	Tape & Reel
0603	1000	2500/Box	3k/reel
0805	1000	2500/Box	3k/reel
1206	1000	2000/Box	3k/reel
1210	1000	2000/Box	3k/reel
1812	1000	1000/Box	2k/reel

## CT4 SERIES RADIAL MULTILAYER (MONO) CERAMIC CAPACITOR CT42 SERIES AXIAL MULTILAYER (MONO) CERAMIC CAPACITOR

### Axial Lead Multilayer Ceramic Capacitors

#### ◆ Size Code, Capacitance and Voltage

Size code	Dimensions(mm)				voltage	Capacitance ranges			
	L max	D max	F (±0.6)			d (±0.05)	COG (NPO)	X7R	Y5V (Z5U)
15	3.8	2.5	5.08   10.0		0.45	25V	OR5~102	101~333	222~224
						50V	OR5~821	101~223	222~154
						100V	OR5~561	101~472	
17	4.30	2.5	5.08   10.0		0.45	25V	OR5~332	331~104	103~105
						50V	OR5~222	331~473	103~684
						100V	OR5~102	331~223	

#### ◆ Packaging style

##### Ammo Taped (Standard Package)

Tape style	A	B	C	D
52.4mm	81(±5)mm	72(±5)mm	258(±5)mm	Lable
26mm	50(±5)mm	110(±5)mm	258(±5)mm	

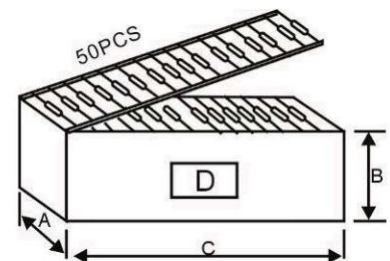

#### Packaging quantity

Size code	Tape and reel	Ammo package	Bulk package
15	5000	5000	1000(500)
17	5000	5000	1000(500)

\*Tape and Reel Package is available on request



### Drawing of capacitors lead shape For CT4 radial MLCC

Standard shape: b, C1, C3; a shape, C2 shape and X shape are on request

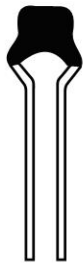

a shape

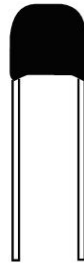

b shape

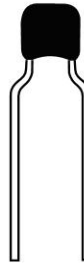

C1 shape



C2 shape



C3 shape



X Shape

### CT4 Standard Size Code Table (for inside chip, shape, pitch size)

Eg.: BC15 means 0805 chip inside, C1 shape, 5.08mm pitch

Pitch \ Inside Chip	Pitch 2.54mm Bulk Package		Pitch 2.54mm Ammo Taped		Pitch 5.08mm Bulk Package		Pitch 5.08mm Ammo Taped	
	Shape	Size Code	Shape	Size Code	Shape	Size Code	Shape	Size Code
0603 (Code A)	b shape	A0b2	b shape	A0b2	C3 shape	AC35	C1 Shape	AC15
0805 (Code B)	b shape	B0b2	b shape	B0b2	C3 shape	BC35	C1 Shape	BC15
1206 (Code C)	b shape	C0b2	b shape	C0b2	C1 Shape	CC15	C1 Shape	CC15
1210 (Code D)	N/A		N/A		b Shape	D0b5	b Shape	D0b5
1808 (Code E)	N/A		N/A		b Shape	E0b5	b Shape	E0b5
1812 (Code F)	N/A		N/A		b Shape	F0b5	b Shape	F0b5

### How to order for CT4 radial MLCC, CT42 axial MLCC

<u>CT4</u>	<u>B</u>	<u>104</u>	<u>K</u>	<u>0050</u>	<u>B0b2</u>	<u>B</u>	<u>000</u>
<b>Type</b>	<b>Material Code</b>	<b>Capacitance Code</b>	<b>Tolerance</b>	<b>Rated Voltage</b>	<b>Size Code</b>	<b>Package Code</b>	<b>Suffix Indicate Customer Special Requirement</b>
CT4 CT42	For ceramic cap B: X7R E: Z5U Z: Y5V U: Y5U P: Y5P V: Z5V X: X5R Y: Y5T D: N4700 N: NPO S: SL T: X7T	pF Code: 1st two digits represent significant figures 3rd digit represents multiplier (number of zeros to follow) 106 = 10uF 105 = 1uF  104 = 0.1uF 100 = 10pF 470 = 47pF 0R1 = 0.1pF R47 = 0.47pF	C: +/-0.25pF  D: +/-0.5pF F: +/-1% G: +/-2% H: +/-2.5% J: +/-5%  K: +/-10% L: +/-15% M: +/-20% Z: +80-20% V: +20-10%	0050: 50VDC 0100: 100VDC 0200: 200VDC 0500: 500VDC 1000: 1KVDC 2000: 2KVDC	B0b2: inside chip 0805, b shape, 2.54mm  <u>CT42 Axial lead MLCC</u> 0017: size code 17  <u>CT4 Radial MLCC Size Code</u> B0b2: inside chip 0805, b shape, 2.54mm	B: Bulk  A: Ammo Taped R: Tape & Reel	<b>000: Indicating Standard</b>  <b>If for cut leads or long leads:</b> 000: mean standard LL 035: cut leads to 3.5mm 040: cut leads to 4mm 250: 25mm long leads

CT4 Size Code (Inside Chip, Lead Shape, Pitch Size)		
Eg.: B0b2 mean inside chip 0805 size, B shape Pitch 2.54mm		
<u>B</u>	<u>0b</u>	<u>2</u>
A: 0603 chip inside B: 0805 chip inside C: 1206 chip inside D: 1210 chip inside E: 1808 chip inside F: 1812 chip inside G: 2220 chip inside H: 2225 chip inside I: 3035 chip inside	0a: a shape 0b: b shape C1: C1 shape C3: C3 shape	2: 2.54mm Pitch 5: 5.08mm pitch 3: 3.5mm pitch